

STATE ELECTION COMMISSION
3rd Floor, Buddha Bhavan, M G Road, Secunderabad - 500 003

No.105/SEC-L/2014

Date:04.03.2014

NOTIFICATION

WHEREAS, the State Election Commission decided to issue Symbol Notification specifying the names of the Recognised National Parties, Recognised State parties in the State of Andhra Pradesh, Recognised State parties of other States, Registered Political parties with reserved symbols, Registered Political parties without reserved symbols and list of free symbols for the office of Member, Municipal Corporation / Municipality / Nagar Panchayat in pursuance of Section 34 of the Greater Hyderabad Municipal Corporation Act, 1955, Section 5A of A.P. Municipalities Act, 1965 and paragraph 10 of the Registration of Political Parties and Allotment of Symbols Order, 2001 as amended from time to time in connection with conduct of 4th Ordinary elections to Municipal Bodies in the State;

Now, therefore, in pursuance of Section 34 of the Greater Hyderabad Municipal Corporation Act, 1955, Section 5A of A.P. Municipalities Act, 1965 and paragraph 10 of the Registration of Political Parties and Allotment of Symbols Order, 2001 as amended from time to time and in supersession of all previous notifications issued on the subject, the State Election Commission, hereby, specifies:-

- (a) In Table I, the Recognised National Parties, Recognised State parties in the State of Andhra Pradesh and Recognised State parties in other States and the symbols respectively reserved for them;
- (b) In Table II, the Registered Political parties with reserved symbol and the symbols respectively reserved for them;
- (c) In Table III, the Registered Political parties without a reserved symbol; and
- (d) In Table IV, list of free symbols for Member, Municipal Corporation / Municipality / Nagar Panchayat.

Sd/- P. Ramakanth Reddy
State Election Commissioner


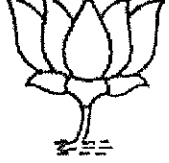






To
The Election Authority & Commissioner & Director of Municipal Administration.
Copy to:
All the Collectors and District Election Authorities (except Hyderabad).
All the Commissioners of Municipal Corporations / Municipalities / Nagar Panchayats.

// Attested //




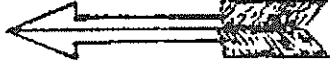

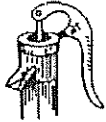

N. Jayaram Reddy
Joint Director

TABLE – I

Recognized National Political Parties

Sl. No.	National Parties	Symbols in English / Telugu	Symbols Reserved
1.	Bahujan Samaj Party, (A.P)	Elephant ఏనుగు	
2	Bharatiya Janata Party,	Lotus కమలం	
3.	Communist Party of India,	Ears of Corn & Sickle కంకి కొడవలీ	
4.	Communist Party of India (Marxist),	Hammer, Sickle & Star సుత్తీ కొడవలీ నక్షత్రం	
5.	Indian National Congress ,	Hand చెయ్యి	
6.	Nationalist Congress Party,	Clock గడియారము	
<u>Recognised State Parties in the State of AP</u>			
1.	Telugu Desam Party,	Cycle పైకిలు	
2.	Telangana Rastra Samithi,	Car కారు	

Recognised State Parties in Other States

1.	All India Anna Dravida Munnetra Kazhagam	Two Leaves రెండు ఆకులు	
2.	Janata Dal (Secular)	A lady farmer carrying paddy on her head వరి మోపుతో ఉన్న మహిళ	
3.	Samajwadi Party	Banyan Tree మట్టి చెట్టు	
4.	Janata Dal (United)	Arrow బాణం	
5.	All India Forward Bloc Party	Lion లయన్	
6.	Rashtriya Lok Dal	Hand Pump చేతి పంపు	

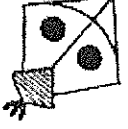
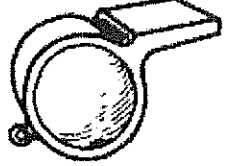
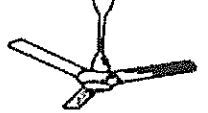
**Sd/- P. Ramakanth Reddy
State Election Commissioner**

// Attested //

N. Jayasimha Reddy
Joint Director

TABLE - II

Registered Political Parties with reserved symbol

Sl.No	Name of the Political Party	Symbols in English / Telugu	Symbols Reserved
1	All India Majlis-E-Ittehadul-Muslimeen,	Kite గాలి పటం	
2	Lok Satta Party	Whistle తరల	
3	Yuvajana Sramika Rythu Congress Party	Ceiling fan పంఖా	

Sd/- P. Ramakanth Reddy
State Election Commissioner

// Attested //

N. Jayaram Reddy
Joint Director

TABLE - III

Registered Political Parties without reserved symbol

Sl. No	Name of the Party
1	All India Stree Shakthi Party
2	Ambedkar National Congress
3	Bahujan Samaj Party (Ambedkar – Phule)
4	BC United Front Party
5	Bharateeya Bhahujana Prajarajyam
6	Bharat Labour Party
7	Bharat Janalok Party
8	BC Bharat Desam Party,F
9	Communist Party of India (Marxist Leninist) (Liberation)
10	Dalita Bahujana Party
11	Ekta Party
12	Gondwana Ganatantra Party
13	Grama Swarajyam Party
14	Great India party
15	Greater Rayalaseema Party
16	Indian Christian Party
17	Indians Front Party
18	Jai Maha Bharat Party
19	Jai Samaikya Andhra Party
20	Jana Rakshana Party
21	Janam Party
22	Jana Prayojana Party
23	Indira Rajiv Congress (Sacrifice for the Nation)
24	Maa Desam Party
25	Majlis Bachao Tahreek
26	Manyaseema Swatantra Party

27	NTR Telugu Desam Party (LP)
28	Nava Bharat party
29	Navatharam Party
30	Nava Samajam Party
31	Navodayam Party
32	Paramatma Party
33	Praja Telangana Samithi
34	Praja Udyog Party
35	Pyramid Party of India
36	Praja Bharat Party
37	Prem Janata Dal
38	Rastriya Praja Congress (Secular)
39	Rayalaseema Rashtra Samithi
40	Republican Party of India
41	Samaikyandhra Parirakshana Samithi
42	Samaikya Telugu Rajyam Party
43	Samajika Telangana Party
44	Samaikya Andhra Samithi
45	Shramajeevi Party
46	Social Welfare Party
47	Telugu Dharmam Party
48	Telangana Bharat Janata Party
49	Telangana Rajyasamithi Party
50	Telangana Party
51	Telangana Communist Party
52	Telangana Congress Party
53	Telangana Democratic Front Party
54	Telangana Ikya Jan Party
55	Telangana Labour Party
56	Telangana Lok Satta Party
57	Telangana Sakalajanula Party

58	Telangana Yuvasena Party
59	Telangana Yuva Shakti Party
60	Telangana Yuvajana Shramika Rajyam Party
61	United Women Front (UWF),
62	Uttarandhra Rashtriya Samithi
63	Vakta Praja Samasyala Saadhana Party (VPSSP)
64	Welfare Party Of India
65	YSR Bahujana Party
66	YSR Praja Party
67	Yuva Telangana Party

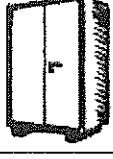

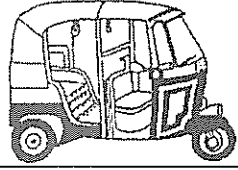

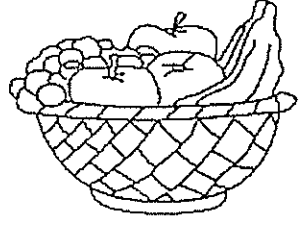
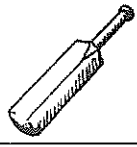

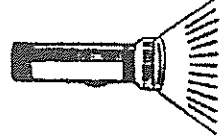
Sd/- P. Ramakanth Reddy
State Election Commissioner

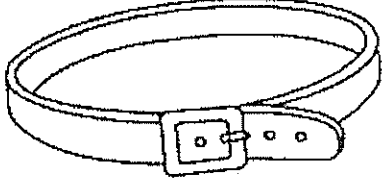
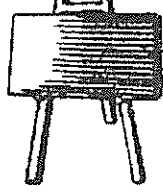
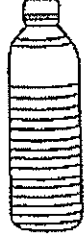


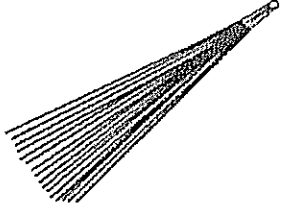

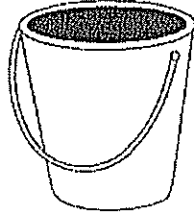
// Attested //


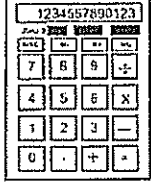
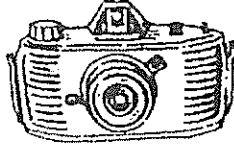

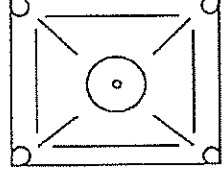
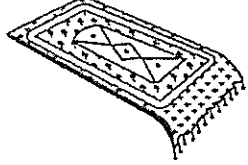
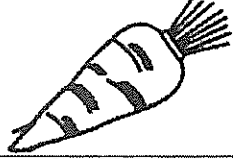
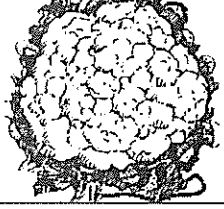
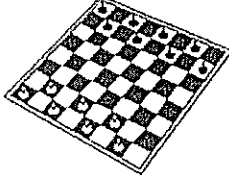
N. Jayaram Reddy
Joint Director

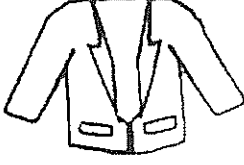

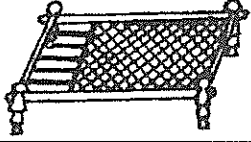

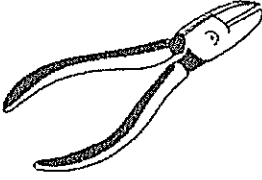
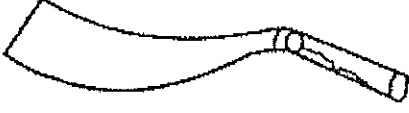
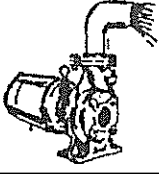
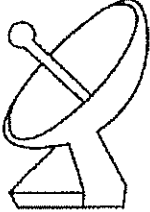
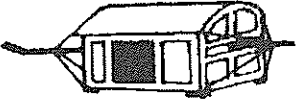
TABLE-IV

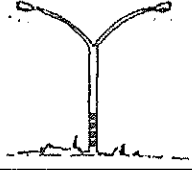

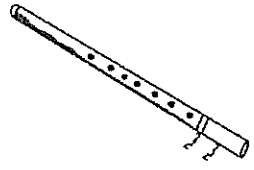


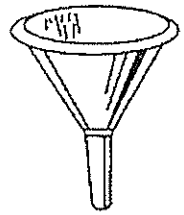
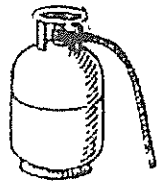
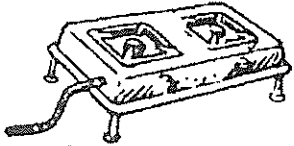

LIST OF FREE SYMBOLS


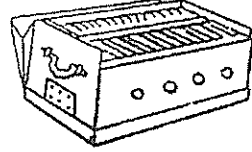


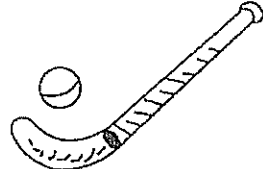


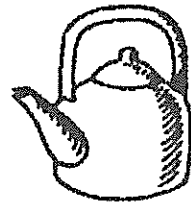
Sl.No	Symbol	Specimen Symbol
1	Almairah బీరువా	
2	Air conditioner ఎయిర్ కండిషనరు	
3	Auto Rickshaw ఆటో రిక్షా	
4	Balloon గాలి బుడగ	
5	Basket containing fruits పండ్ల బుట్ట	
6	Bat బ్యాట్	
7	Batsman బ్యాట్స్మెన్	
8	Battery torch బ్యాటరీ లైట్	

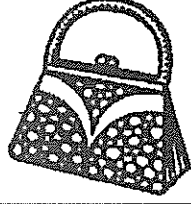

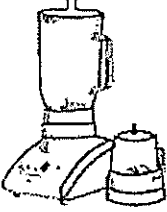
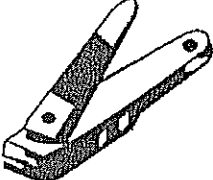

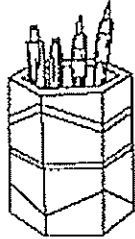
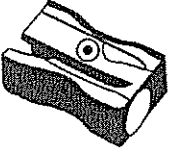

9	Belt బెల్ట్	
10	Black Board నల్ల బోర్డు	
11	Bottle బోటి	
12	Bread బ్రెడ్	
13	Brief case బ్రీఫ్ కేస్	
14	Broom బ్రూమ్	
15	Brush బ్రష్	
16	Bucket బకెట్	


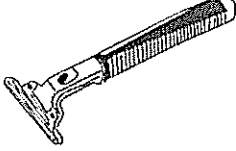
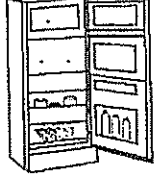


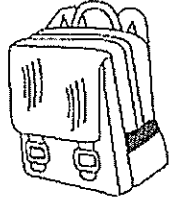
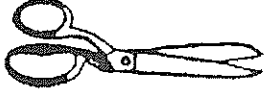
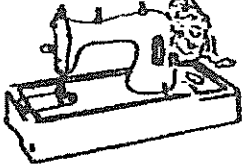

17	Cake కేక్	
18	Calculator క్యాలక్యులేటర్	
19	Camera కెమెరా	
20	Candles కొవ్వొత్తులు	
21	Carom Board క్యారమ్ బోర్డు	
22	Carpet కార్పెట్	
23	Carrot క్యారెట్	
24	Cauliflower కాలిఫ్లవర్	
25	Chess Board చెస్ బోర్డు	

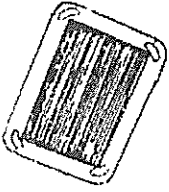


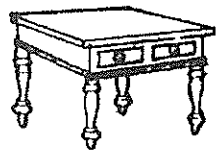


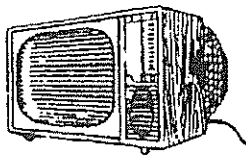
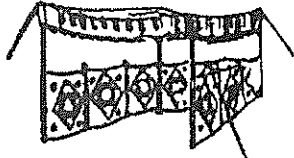
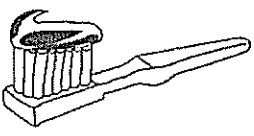
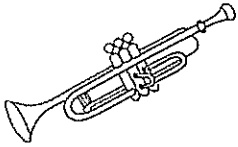
26	Coat కోటు	
27	Coconut కొబ్బరికాయ	
28	Cot మంచము	
29	Cup and saucer కప్పు మరియు సాసరు	
30	Cutting Plier కటింగ్ ప్లయర్	
31	Dao కత్తి	
32	Diesel Pump డిజిల్ పంపు	
33	Dish Antenna డిష్ యాంటెన్నా	
34	Dolli పల్లకి	


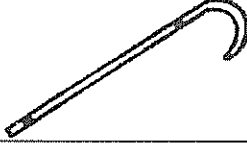
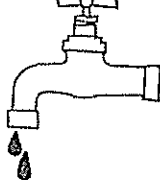
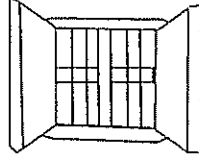
35	Electric Pole విద్యుత్ స్తంబం	
36	Envelop కవరు	
37	Flute ఫ్లూట్	
38	Frock గౌను	
39	Frying Pan మూకుడు	
40	Funnel గరాటా	
41	Gas Cylinder గ్యాస్ సిలెండర్	
42	Gas Stove గ్యాస్ పాయి్య	
43	Glass Tumbler గాజు గ్లాసు	

44	Grapes దాక్ష పండ్లు	
45	Harmonium హార్మోనియం	
46	Hat హాట్	
47	Helmet హెల్మెట్	
48	Hockey and Ball హాకీ మరియు బంతి	
49	Ice Cream ఐస్ క్రీమ్	
50	Iron ఇస్త్రీ పెట్టె	
51	Kettle కెటిల్	

52	Lady purse లేడీ పర్సు	
53	Letter Box పోస్టు డబ్బా	
54	Mixee మిక్సీ	
55	Nail Cutter నెయిల్ కట్టర్	
56	Neck Tie నెక్ టై	
57	Pen Stand పెన్ స్టాండు	
58	Pencil Sharpner పెన్సిల్ షార్పనర్	
59	Pot కుండ	

60	Pressure Cooker పెషర్ కుక్కర్	
61	Razor రేజర్	
62	Refrigerator రిఫిజిరేటర్	
63	Ring ఉంగరము	
64	Saw రంపం	
65	School Bag స్కూల్ బ్యాగ్	
66	Scissors కత్తెర	
67	Sewing Machine కుట్టు మిషను	
68	Shuttle షటిల్	

69	Slate పలక	
70	Stethoscope స్టెతస్కోప్	
71	Stool స్టూలు	
72	Table టేబులు	
73	Table Lamp టేబులు బల్బు	
74	Telephone టెలిఫోన్	
75	Television దూర దర్శిని	
76	Tent టెంట్	
77	Tooth Brush టూత్ బ్రష్	
78	Trumpet ట్రంపెట్	

79	Violin వయోలిన్	
80	Walking Stick చేతి కర్ర	
81	Water Tap నీటి పంపు	
82	Window కిటికీ	

Sd/- P. Ramakanth Reddy
State Election Commissioner

// Attested //

A. Jayaram Reddy
Joint Director